

Инструкция по сборке Instructions for assembling furniture Instrukcja montażu mebli

Набор модульной мебели Collection Kolekcja mebli

«TIFFANY»

Шкаф 1D2S

Cupboard 1D2S

Szafa 1D2S

AH-024.01.00.00

Шкаф 1Z2S

Cupboard 1Z2S

Szafa 1Z2S

AH-024.03.00.00



Дата изготовления

Production date

Data produkcji

Штамп ОТК

Stamp of Quality Department

Pieczęć Działu Jakości

ИООО « АНРЭКС »

Республика Беларусь, 224004
г.Брест, ул. Катин Бор, 119
тел/факс (+375162) 29-74-68



ЕАЭС№ ВУ/112 11.01. ТР025 018 03775

от 29.03.2018

по 28.03.2023

Инструкция по эксплуатации.

Качество и комплектность изделия рекомендуется проверять в магазине при покупке в распакованном виде. Сборка изделия должна производиться в порядке, изложенном в настоящей инструкции. В процессе эксплуатации изделий необходимо периодически затягивать ослабленные винтовые соединения. В случае необходимости перемещения изделия по квартире перед его перестановкой, необходимо полностью освободить его от груза (матраца). Во избежание поломки имеющихся опор передвигание производить приподнимая изделие над уровнем пола. Запрещён прямой контакт с водой. Удаление пыли с изделий следует производить слегка влажной мягкой салфеткой. Во избежание коробления деталей и изменения цвета изделия следует избегать установки мебели на прямых солнечных лучах.

При эксплуатации изделий набора **ЗАПРЕЩАЕТСЯ:**

- устанавливать мебель вблизи отопительных приборов и вплотную к сырým стенам и в помещениях с относительной влажностью более 70%;
- температура нагрева элементов мебели не должна превышать +40°C.
- в процессе сборки и эксплуатации изделий набора становиться ногами на горизонтальные щиты и витрины;
- применять химические чистящие средства для уборки мебели;

Гарантии изготовителя

1. Гарантийный срок эксплуатации изделия - 24 месяца со дня продажи магазином. В период гарантийного срока изготовитель гарантирует ремонт изделий или их замену, если потребителем не нарушены правила эксплуатации.
2. Претензии предъявляются потребителем непосредственно в торгующую организацию, в которой была приобретена мебель, предъявив настоящую "Инструкцию по сборке" и копию товарного чека.
3. Изделия **Шкаф 1D2S, Шкаф 1Z2S**, входящие в состав набора модульной мебели **«TIFFANY»**, соответствует требованиям ГОСТ 16371-2014, ТР ТС 025/2012.
4. Срок службы мебели - 5 лет.
5. Предприятие-изготовитель оставляет за собой право вносить изменения в конструкцию изделия, не ухудшая его конструктивные и эксплуатационные характеристики.
6. Для сборки изделий рекомендуется привлекать квалифицированных специалистов.

Запах.

От новой мебели может исходить запах материалов, из которых она изготовлена. Запах может сохраняться в течение трёх недель с момента сборки. Для снижения интенсивности запаха рекомендуется:

-для мягкой мебели - пропылесосить изделие и проветрить помещение.

Повторять 3-4 раза в день.

-для корпусной мебели – протирать тканью, смоченной мягким моющим средством, вытирать чистой сухой тканью и проветривать помещение, предварительно открывая все двери и ящики изделия.

Повторять 3-4 раза в день.

Важно! Сохраните, пожалуйста, инструкцию в случае повторной сборки мебели или рекламации. В случае составления рекламации пользуйтесь, пожалуйста, обозначением из инструкции сборки.

PL

Przy eksploatacji mebli zabrania się:

- ustawiać meble w pobliżu grzewczych przyrządów i obok wilgotnych ścian, a także w pomieszczeniach ze względną wilgotnością więcej niż 70%;
- temperatura nagrzewania elementów mebli nie może przekraczać +40°C;
- w trakcie montażu i eksploatacji mebli stawać nogami na poziome panele i witryny;
- stosować chemiczne środki czyszczące do sprzątania mebli;
- nie należy narażać na kontakt z wodą.

Gwarancje producenta

1. Gwarancyjny termin eksploatacji wyrobu - 24 miesiące z dnia sprzedaży. W okresie gwarancyjnego terminu producent gwarantuje naprawę wyrobów lub ich zamianę, jeżeli reguły eksploatacji nie zostały naruszone przez nabywcę.
2. Roszczenia są przekazywane przez nabywcę bezpośrednio do handlującej organizacji, w której były nabyte meble, tylko przy okazaniu danej "Instrukcji montażu" wraz z dokumentem zakupu.
3. Wyroby **Szafa 1D2S**, **Szafa 1Z2S**, wchodzący w zestaw mebli «**TIFFANY**», odpowiada wymaganiom Norm Państwowych 16371-2014, TP TC 025/2012
4. Trwałość użytkownika mebli - 5 lat.
5. Firma-producent pozostawia za sobą prawo do wprowadzania zmian w konstrukcje wyrobów, nie pogarszając ich konstruktywne i eksploatacyjne charakterystyki.
6. Do montażu wyrobów zaleca się skorzystanie z pomocy wykwalifikowanych specjalistów.

Zapach.

Nowe meble mogą wydzielać zapach materiałów, z których są wykonane. Zapach może utrzymywać się do trzech tygodni od momentu montażu. Aby zmniejszyć intensywność zapachu, zaleca się:

- w przypadku mebli tapicerowanych - odkurzyć produkt i przewietrzyć pomieszczenie. Powtarzaj 3-4 razy dziennie.
- dla mebli szafkowych - przetrzyj ściereczką zwilżoną łagodnym detergentem, przetrzyj czystą, suchą ściereczką i przewietrz pomieszczenie, uprzednio otwierając wszystkie drzwi i szuflady produktu. Powtarzaj 3-4 razy dziennie.

Ważne! Proszę zachować instrukcję w razie ponownego montażu mebli lub reklamacji. Podczas składania reklamacji prosimy o korzystanie z oznaczeń z instrukcji.

EN

Instruction manual.

It's advised to check the quality and completeness of the product in the store when buying unpacked. Assembling of the product should be done the way it's described in this manual. While the product is in service loose screw connections should be periodically tightened. If it's necessary to move items around the apartment before moving you should release the product completely from the load (the mattress). To prevent damage to existing supports the product should be lifted before moving. Furniture should not be exposed to contact with water. Dusting the product should be done with a slightly damp soft cloth. To prevent warping of parts and discoloration of products do not install furniture in direct sunlight.

While the product is in service it's **PROHIBITED TO**:

- Install furniture near heating devices, close to the raw walls and in rooms with a relative humidity of more than 70%;
- heat elements of furniture to the temperature higher +40°C;
- step on the horizontal shields and windows during assembly and use of the products set;
- use chemical cleaners for cleaning furniture;

Manufacturer's warranty.

1. The warranty period of use of the product - 24 months from the date of sale. During the warranty period the manufacturer guarantees repair or replacement of products, if the user has not violated operating rules.
2. Claims should be made by the consumer directly to the trading organization, in which furniture was purchased, presenting the "Instruction manual" and a copy of the sales receipt.
3. The product, **Cupboard 1D2S**, **Cupboard 1Z2S**, which is part of a set of «**TIFFANY**», meets the requirements of GOST 16371-2014, TR TS 025/2012.
4. The lifetime of furniture - 5 years.
5. The manufacturer reserves the right to make changes in product design, without compromising its design and application requirements.
6. To assemble the products it's recommended to attract qualified personnel.

Smell.

New furniture may emit the smell of the materials from which it is made. The smell can persist for up to three weeks from the time of assembly. To reduce odor intensity, it is recommended:

- for upholstered furniture - vacuum the product and ventilate the room.

Repeat 3-4 times a day.

- for cabinet furniture - wipe with a cloth dampened in a mild detergent, wipe with a clean, dry cloth and ventilate the room, previously opening all doors and drawers of the product.

Repeat 3-4 times a day.







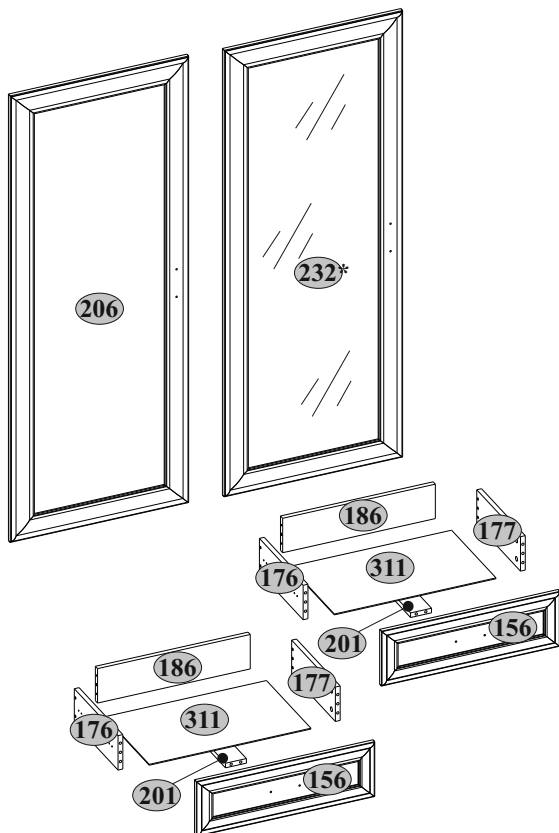
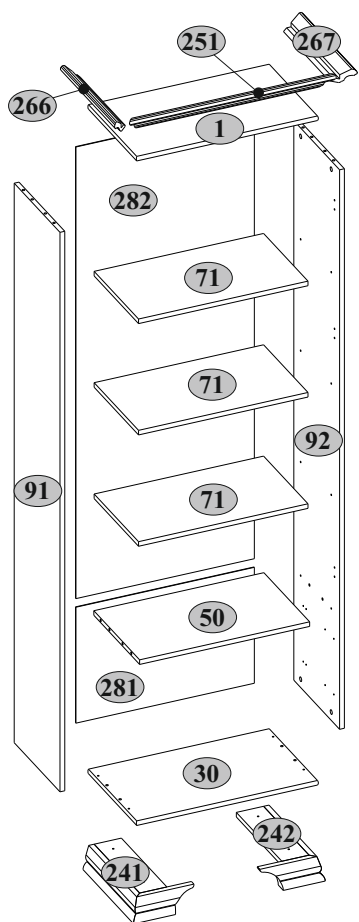

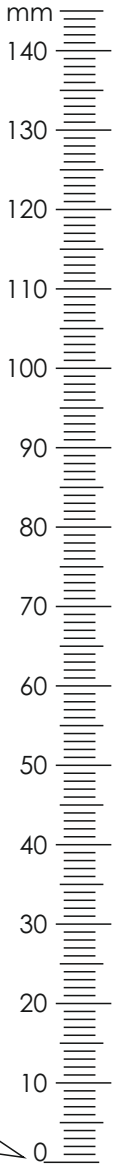



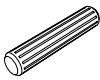













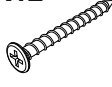

It is important! Keep the instruction in case of reassembly of furniture or complaint. When making a claim use the notation from the instruction.

- * Шкаф 1Z2S
- * Cupboard 1Z2S
- * Szafa 1Z2S

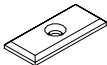
№ п/п	Длина мм.	Ширина мм.	Толщина мм.	Кол-во шт.	№ пачки
1	608	355	16	1	1/6
30	608	355	16	1	1/6
50	568	335	16	1	1/6
71	566	325	16	3	6/6
91	1950	335	16	1	3/6
92	1950	335	16	1	3/6
156	596	191	19	2	3/6
176	320	120	16	2	3/6
177	320	120	16	2	3/6
186	510	120	16	2	1/6
201	320	70	16	2	3/6
206	1556	596	19	1	4/6
232*	1556	596	19	1	4/6
241	210	370	80	1	2/6
242	210	370	80	1	2/6
251	690	80	19	1	3/6
266	396	80	19	1	3/6
267	396	80	19	1	3/6
281	404	596	2,5	1	4/6
282	1574	596	2,5	1	4/6
311	540	325	2,5	2	1/6



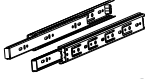



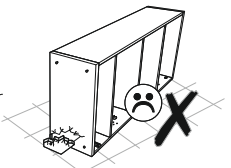
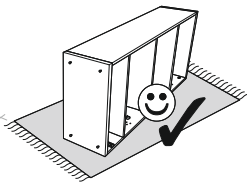
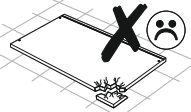
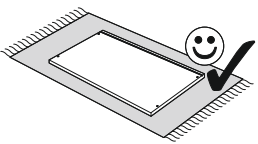

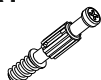
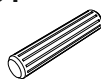

A1  5x28 22	A2  Ø15x12 22	B5  10x50 1	C1  8x35 22
D1  4	E1  4	G  1,5x26 62	H18  3
I  S4 1	M1  M4x12 4	M12  M4x25 2	N1  6
P4  Ø5 12	Q  6	R3  3x20 22	Rt4  3,5x25 6
R10  4x30 4	R12  4x40 4	R23  6,3x13 8	R24  7x50 8
R27  5,0x13 20	R30  2,9x9,5 4	R102  3,5x16 8	S3  2
S5  Ø18 12	S6  1	S11  Ø5 8	U8  120° 2
Z10  300 2	W1  250 1		R102  3,5x16 4

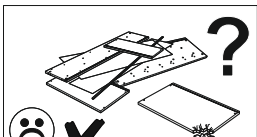

1A

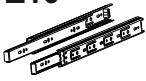
A1  5x28	C1  4 8x35	D1  8	R23  4 6,3x13	R27  8 5,0x13
		S11  Ø5		
		Z10  8 300		

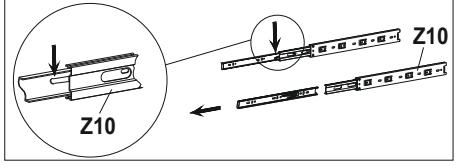
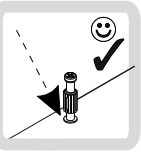
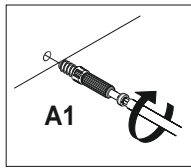
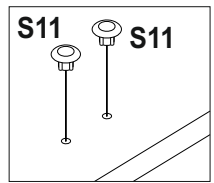
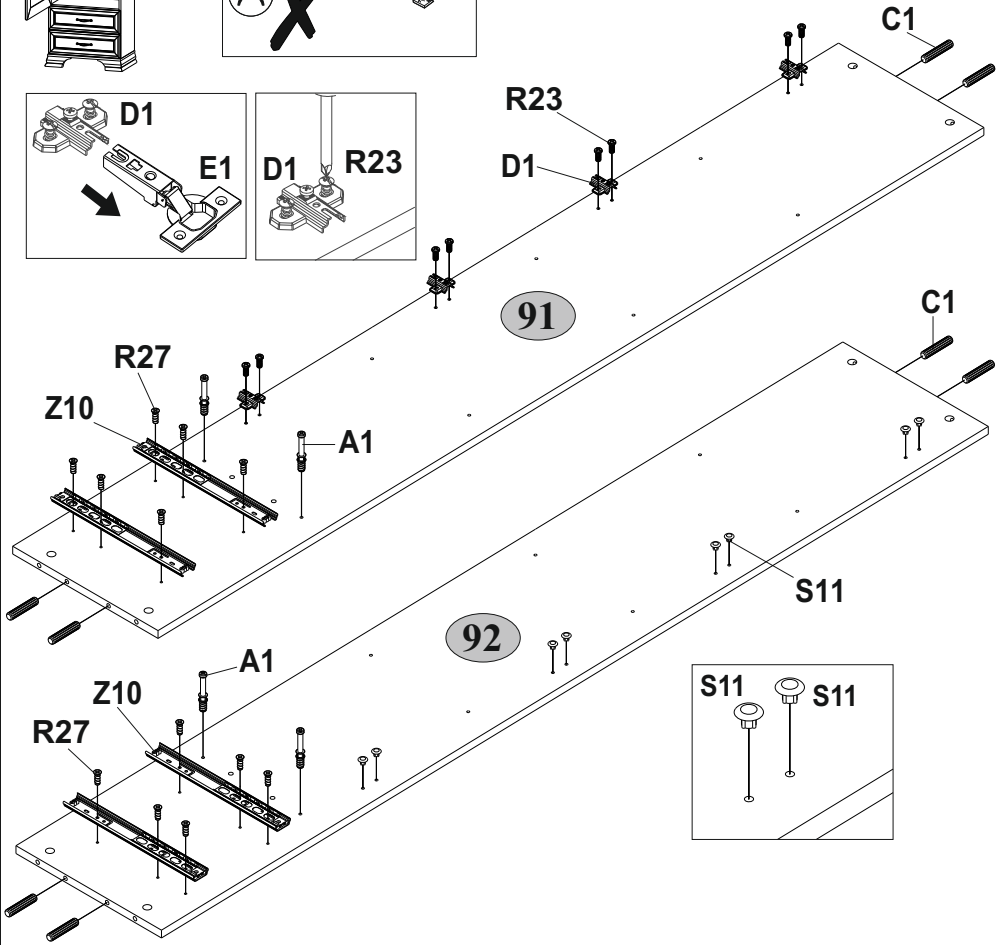
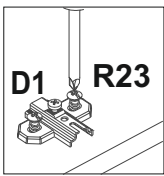
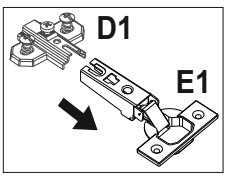
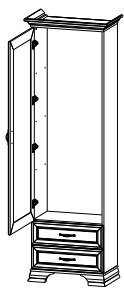

1B

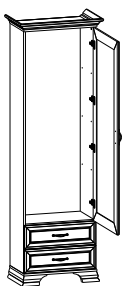

A1 5x28	C1 4 8x35	D1 8	R23 4 6,3x13	R27 8 5,0x13
		S11 Ø5	Z10 8 300	4

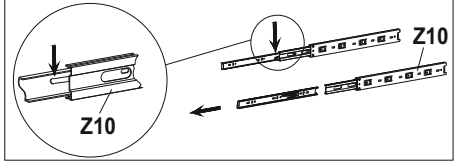
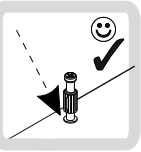
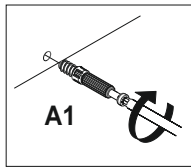
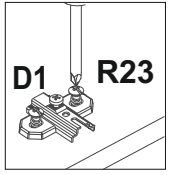
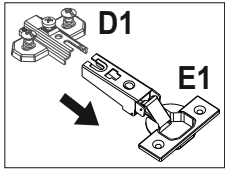
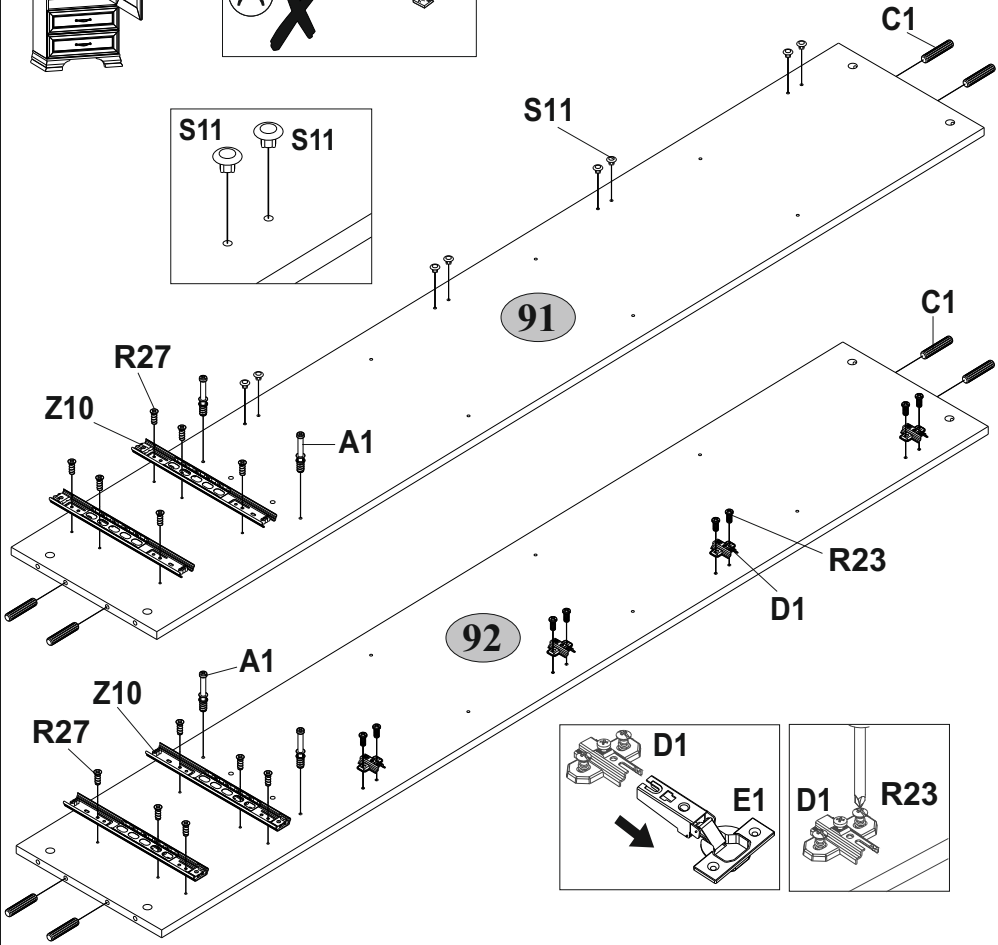
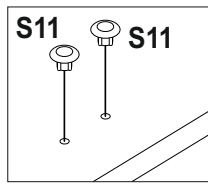

2

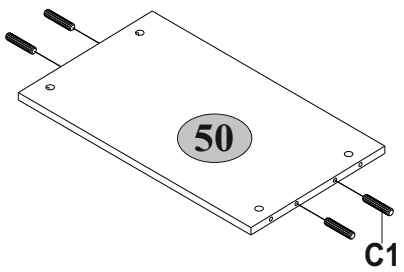
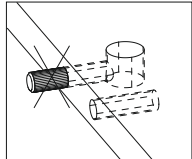
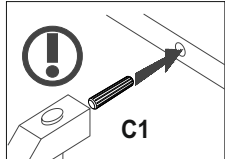
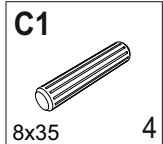

3

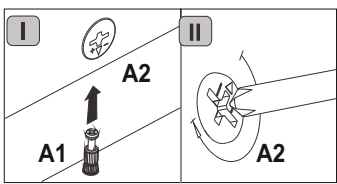
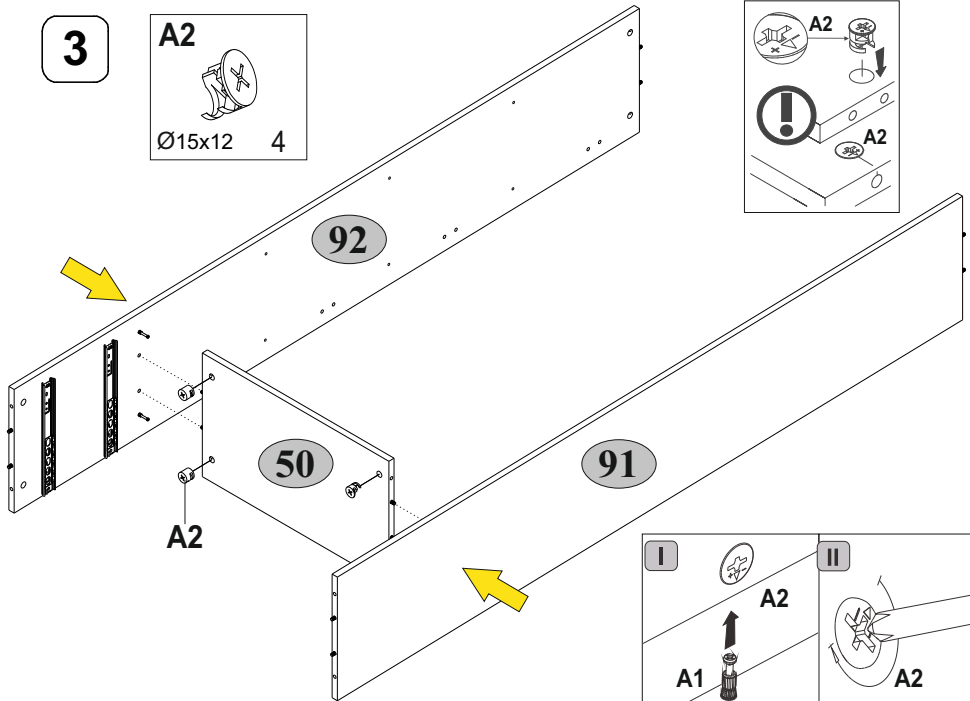
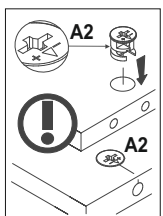
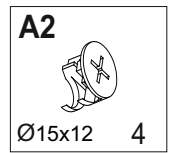

4

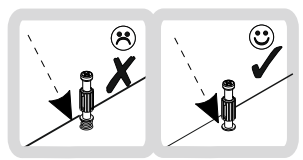
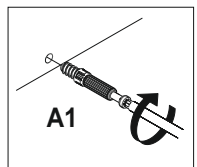
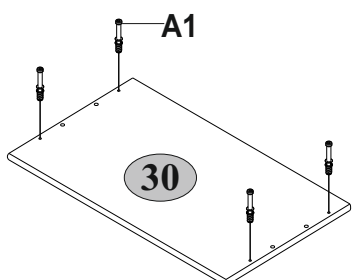
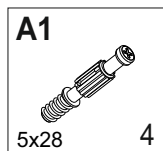

5

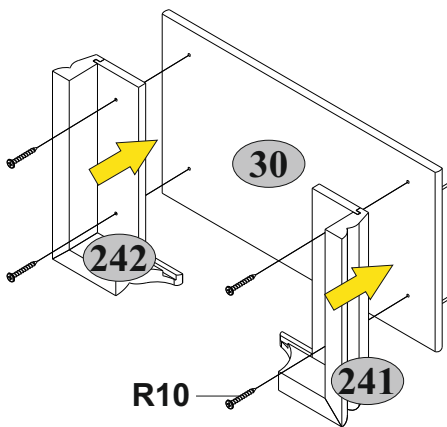
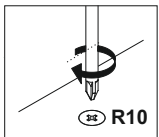
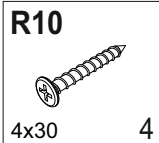

6

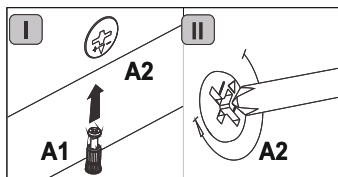
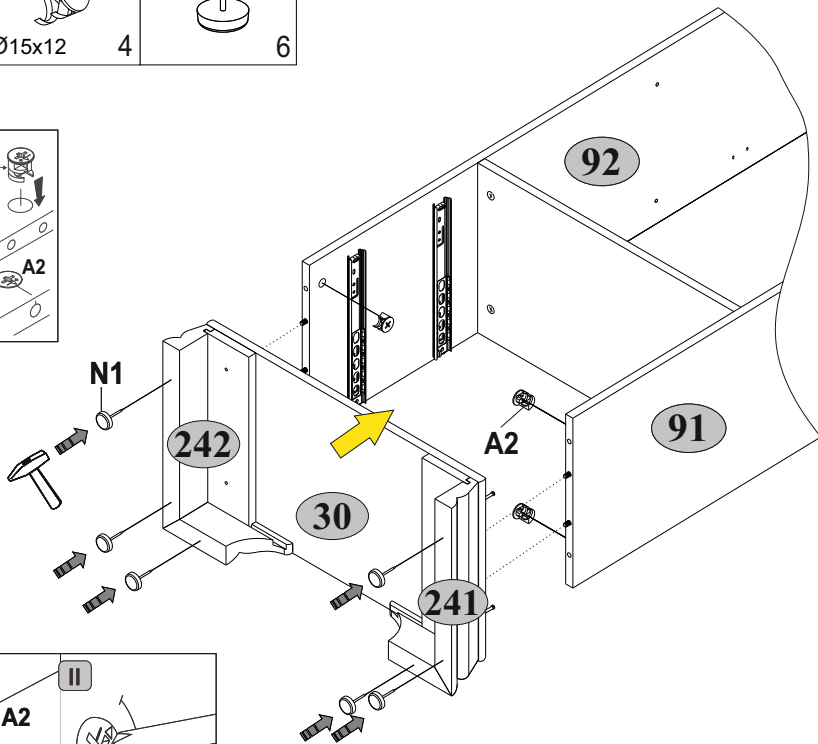
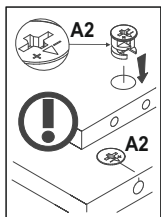
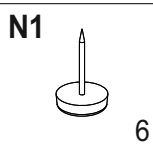
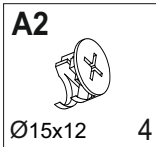

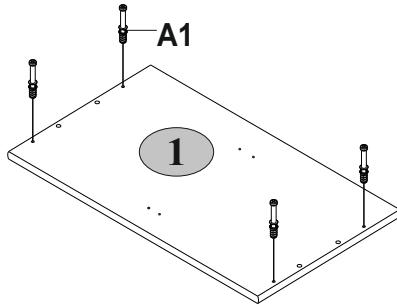
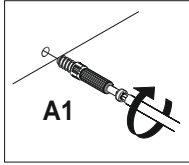
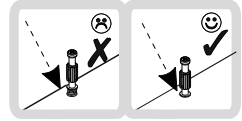
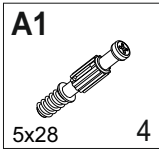

7

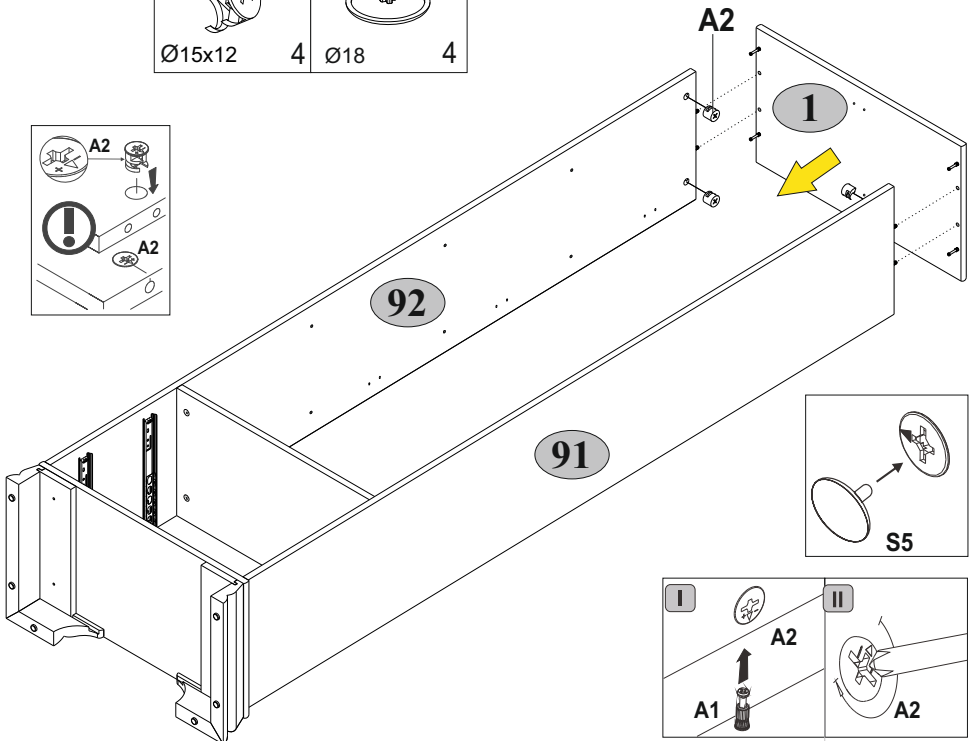
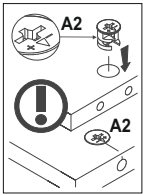
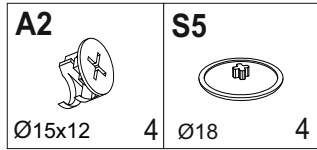

8



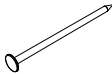

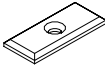

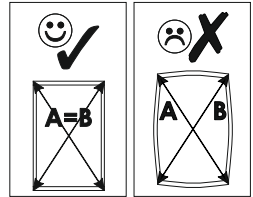
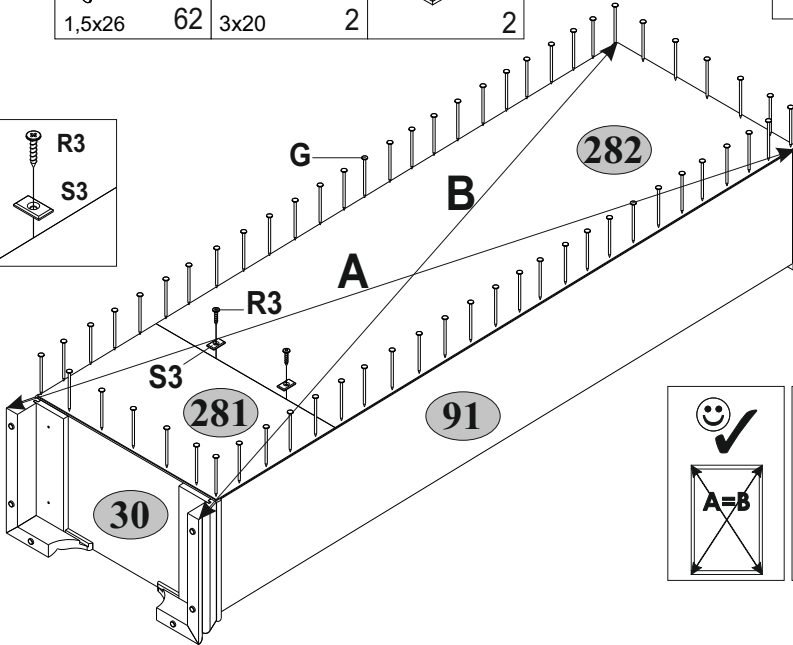
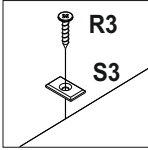
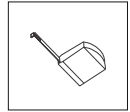
9

G  1,5x26 62	R3  3x20 2	S3  2
------------------------------------------------------------------------------------------------------------	----------------------------------------------------------------------------------------------------------	-----------------------------------------------------------------------------------------------------

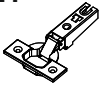

10

E1  4	R102  3,5x16 8	H18  1	M12  M4x25 2
------------------------------------------------------------------------------------------------------	---------------------------------------------------------------------------------------------------------------	-------------------------------------------------------------------------------------------------------	-------------------------------------------------------------------------------------------------------------

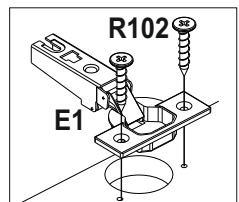
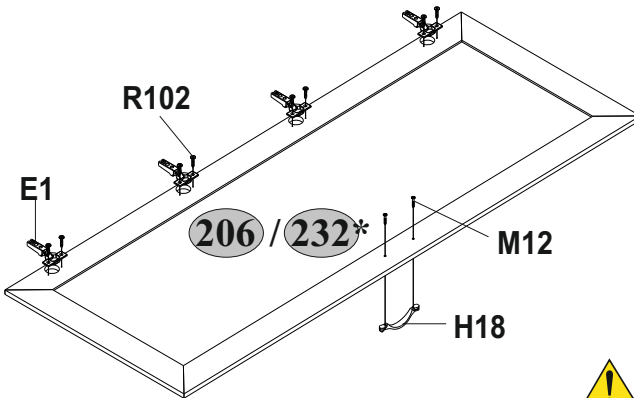

11 x2

C1

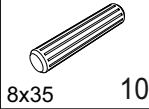

R27

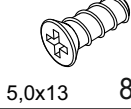

Z10

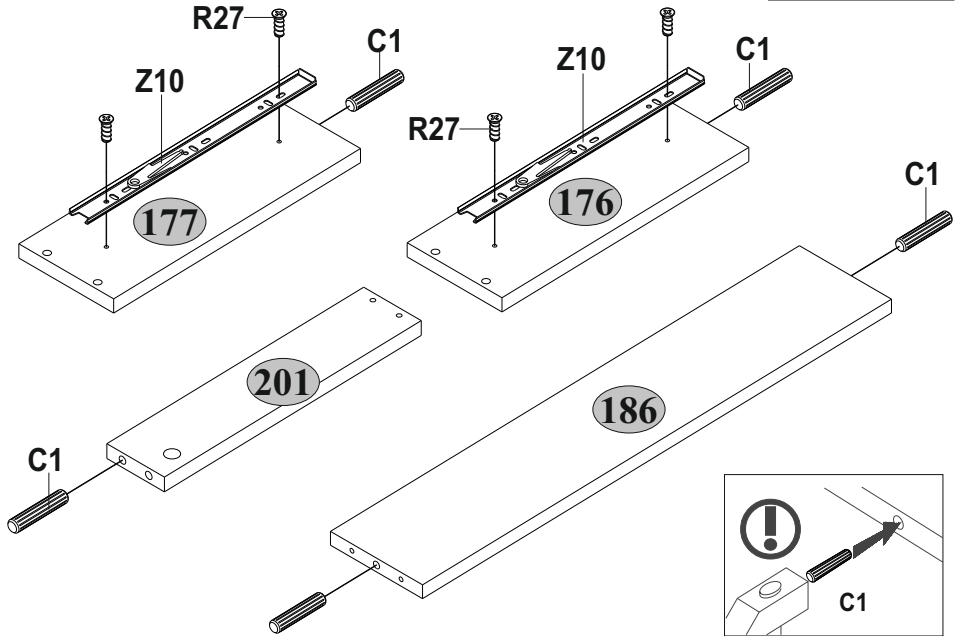
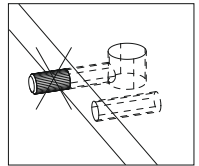
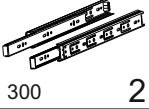

12 x2

A1

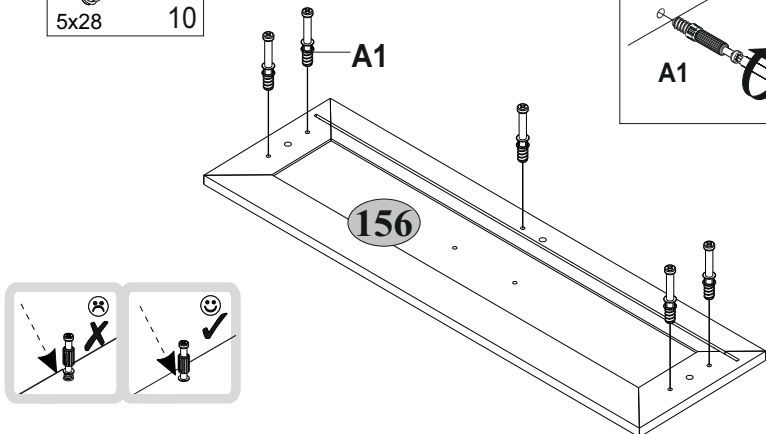
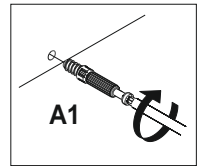
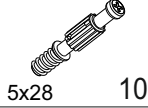

13 x2

A2



Ø15x12

8

H18



2

I



S4

M1



4 M4x12

R24



7x50

8

S5



Ø18

8

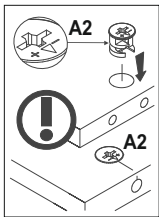

R24

177

186

156

H18

A2

M1

R24

176

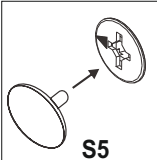
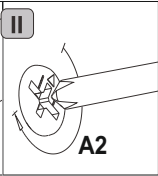
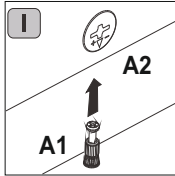

14 x2

R3



3x20

20

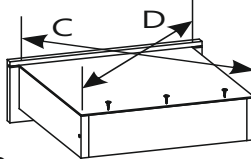
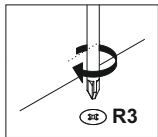

C=D

I

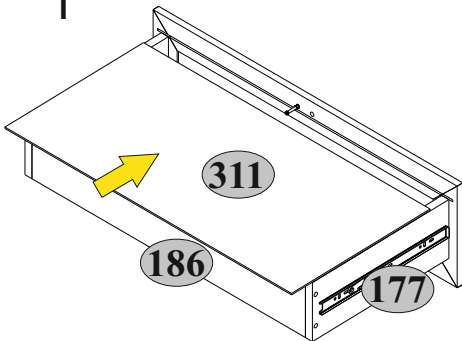

311

186

177

II

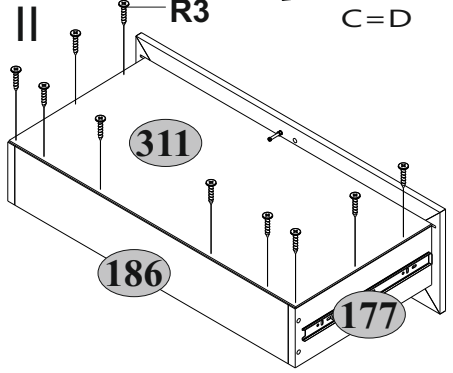

186

177

15 x2

A2



Ø15x12

2

R12



4x40

4

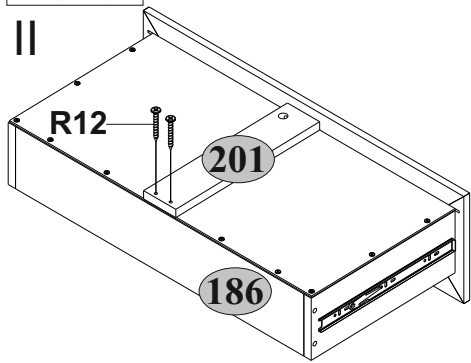
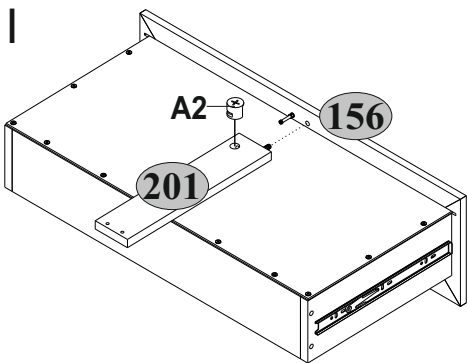
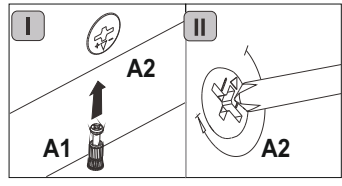
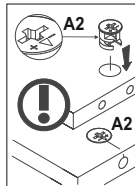

16

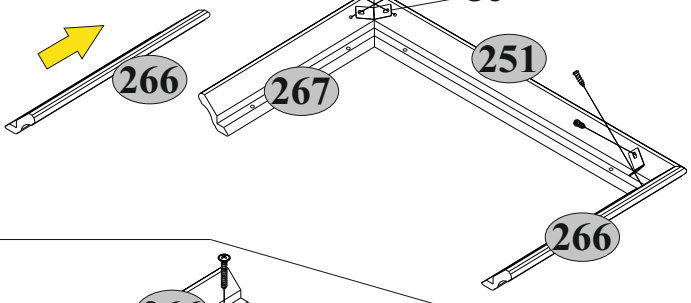
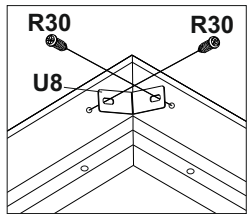
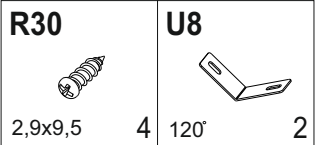
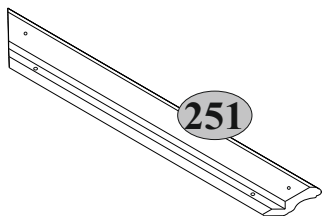
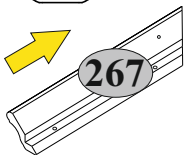

17

Rt4



3,5x25

6

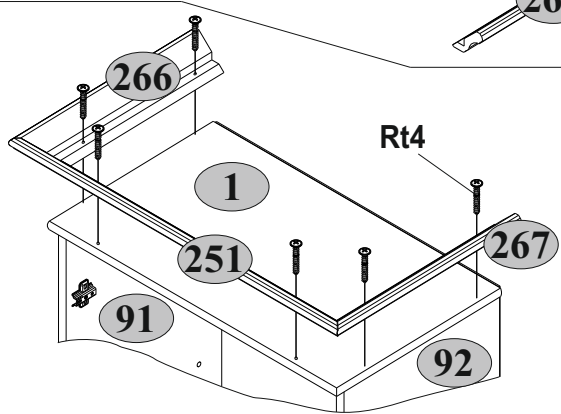

18

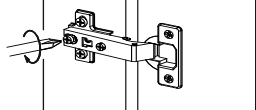
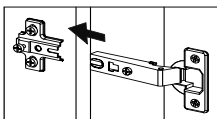
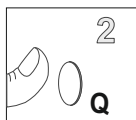
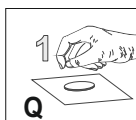
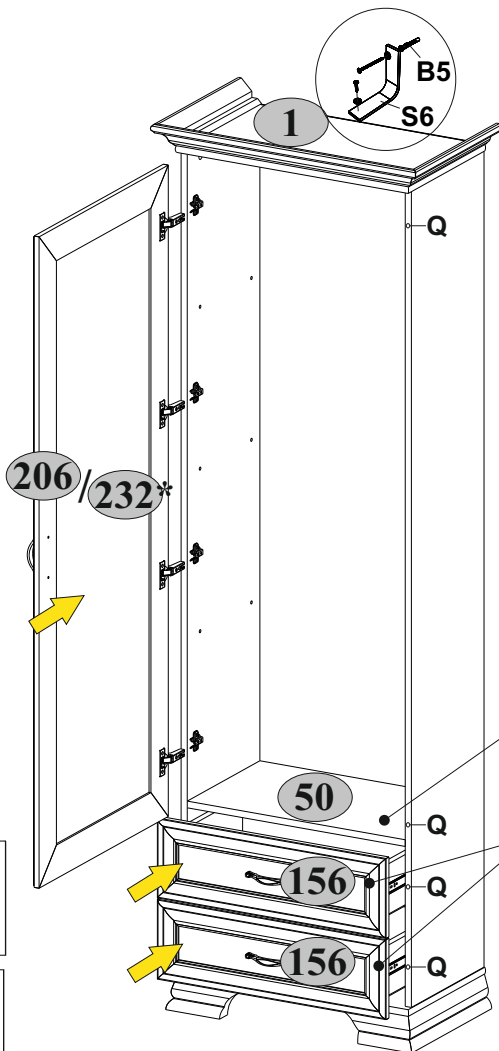
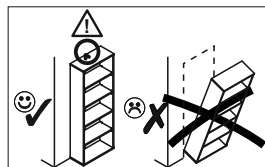
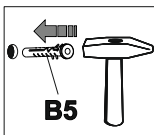
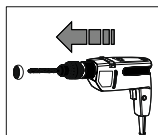
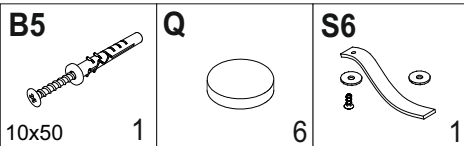

20

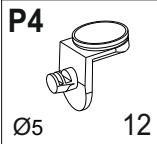

A

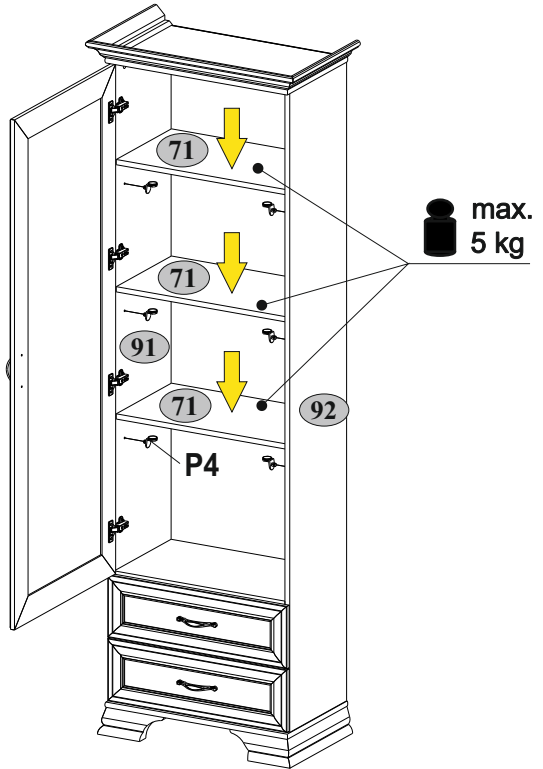
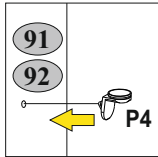

B

